

Prosman Dakramen

...sieraden voor uw rieten dak

Catalogus 2010

**Nieuw
Shutters**
zie pag. 10



- **15 standaard dakramen**
- **insektenhorren**
- **gordijnroeden**
- **maatwerk volgens uw wensen**

Prosman Dakramen

...sieraden voor uw rieten dak

P190

De standaard uitvoering:

- Wij gebruiken meranti hardhout, voor een lange levensduur en weinig onderhoud.
- In de ramen is dubbel glas (HR++ isolatieglas) geplaatst.
- Tussen het glas zitten aluminium afstandhouders en aan beide zijden van het glas bevinden zich houten roeden.
- Luxe hang- en sluitwerk; de modellen P90, P110 en P330 hebben een meerpuntssluiting met ventilatiestand. Het raam kan helemaal geopend worden. Alle overige modellen hebben respectievelijk 1, 2 of 3 draai-/kiepramen.
- De dakramen worden af fabriek 2x wit gegrond geleverd.
- Prosman Dakramen zijn snel leverbaar, meestal uit voorraad.



Valraam met ventilatiestand bij de modellen P90, P110 en P330.



De draai-/kiepramen op alle overige modellen zijn gemakkelijk van binnenuit te reinigen.

P90



P150





P190



P120



P100



P450



P150



P225



P110



P480

Eindeloos combineren met Prosman Dakramen

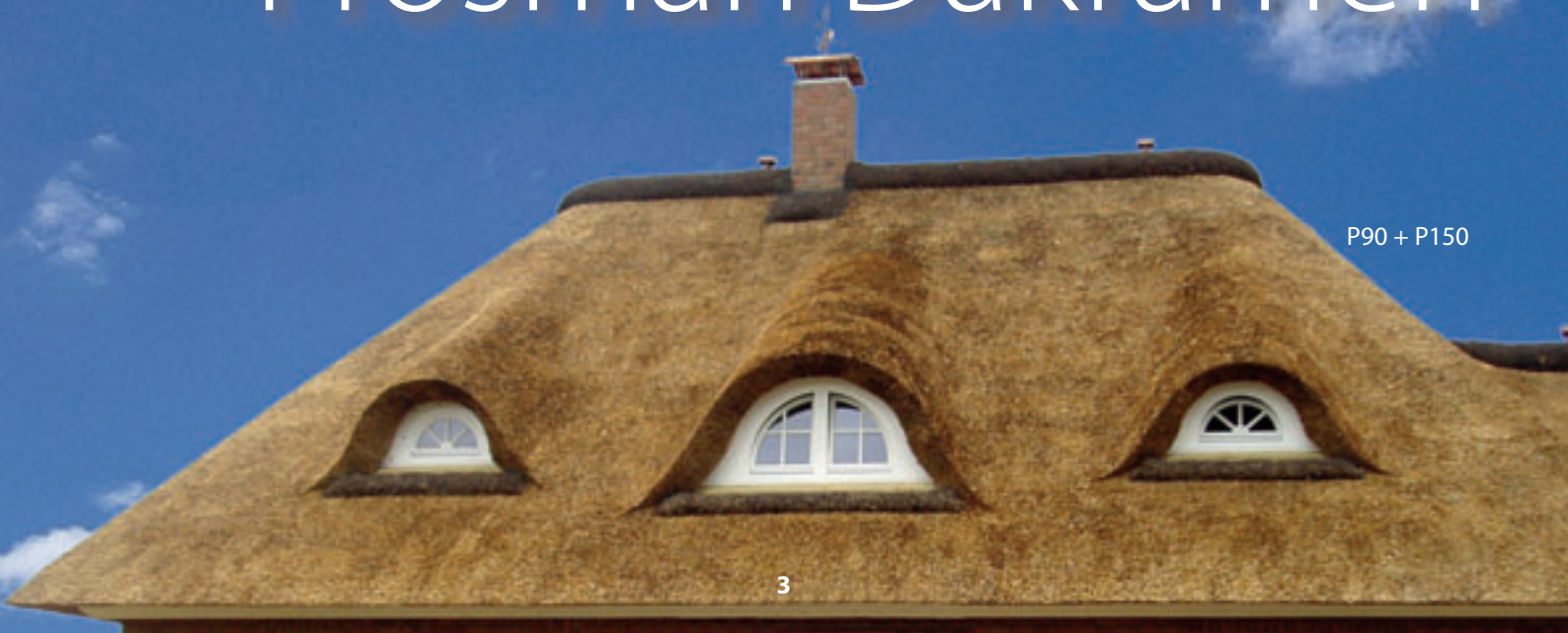

P90 + P150

Het standaard programma

De maten zijn in meters, wijzigingen voorbehouden

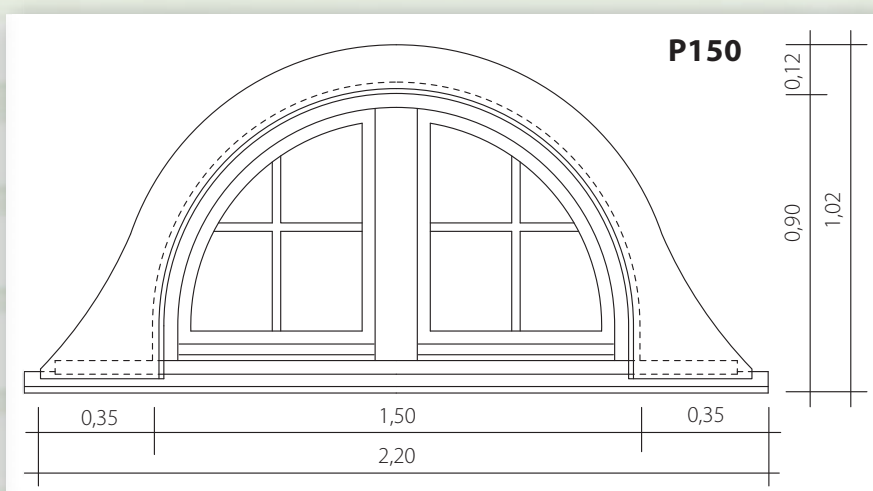
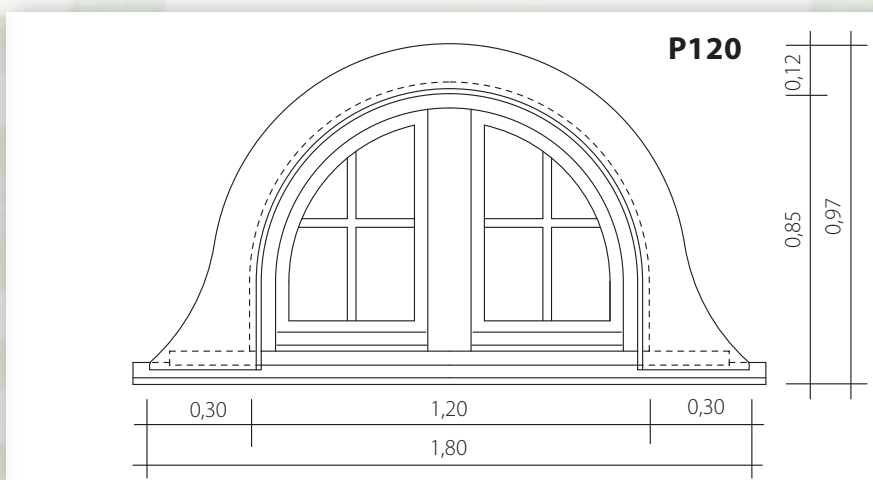
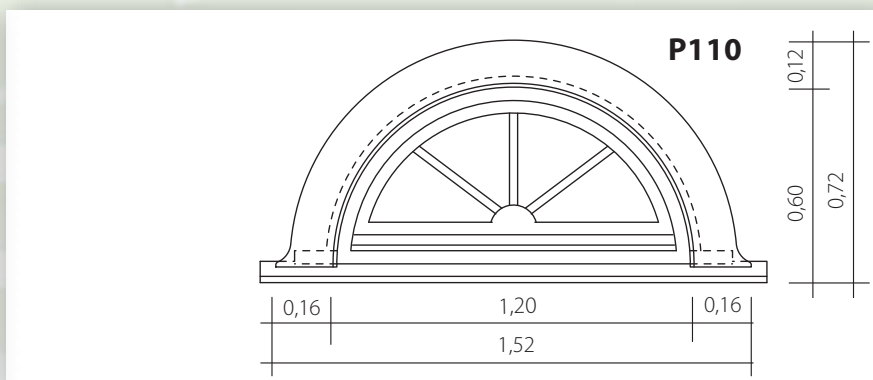
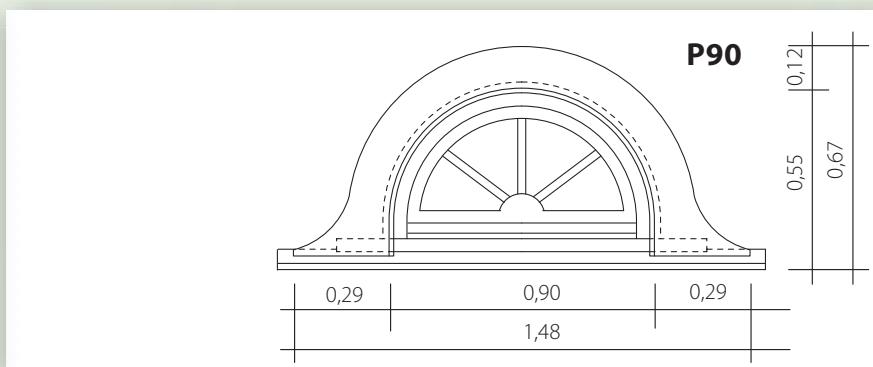

Het standaard programma

De maten zijn in meters, wijzigingen voorbehouden

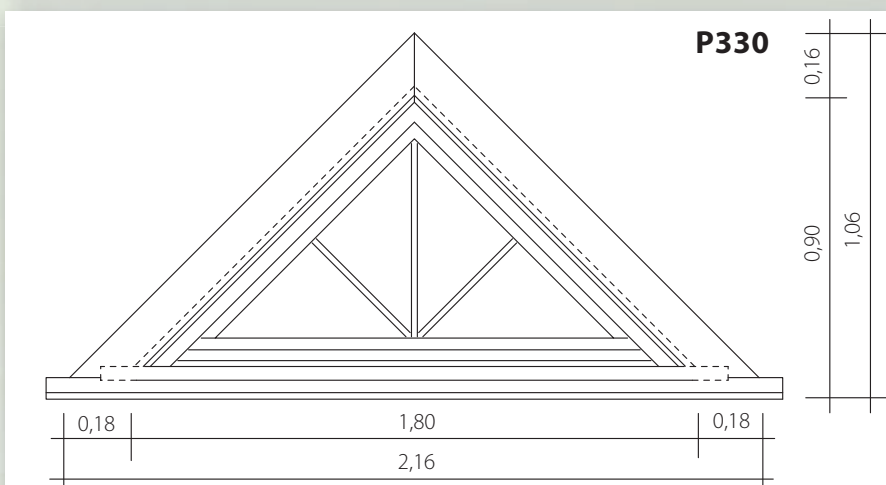
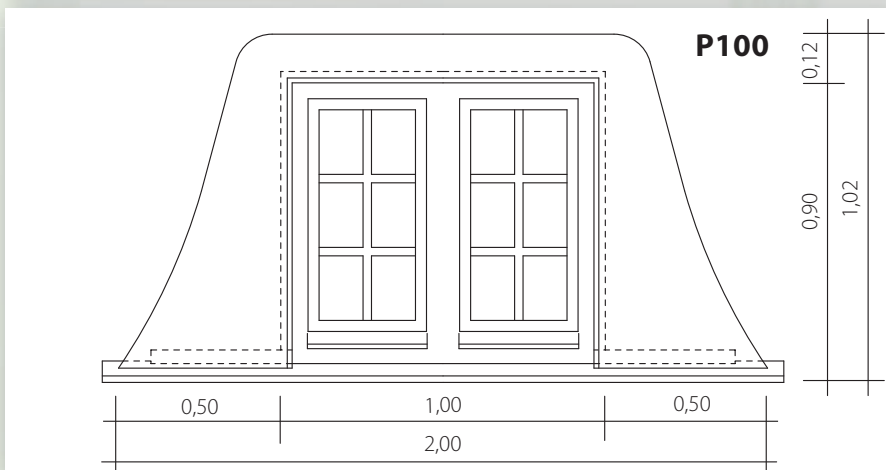
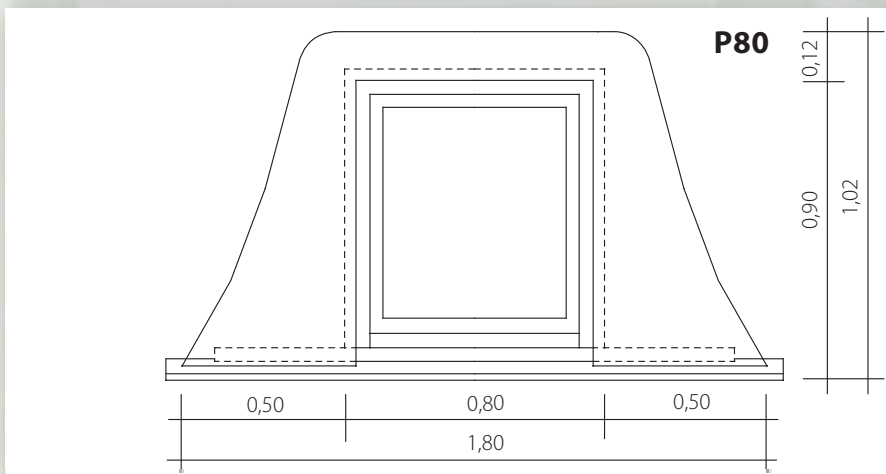
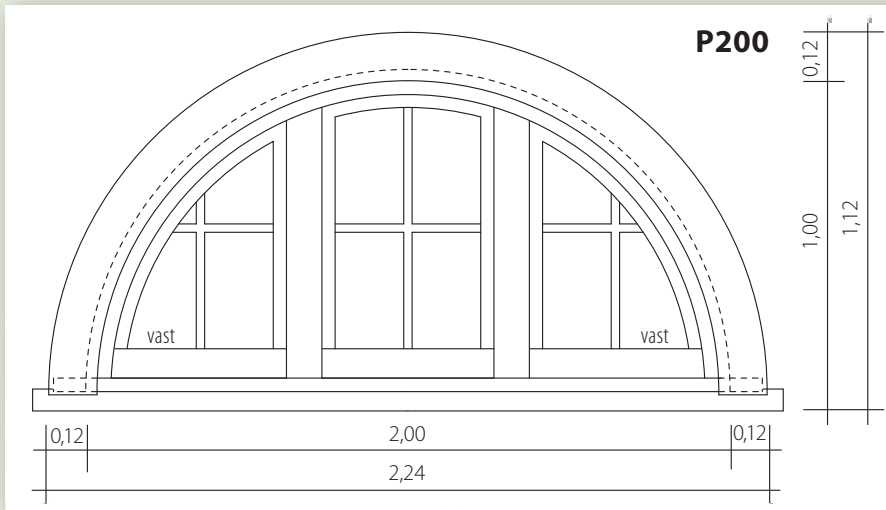

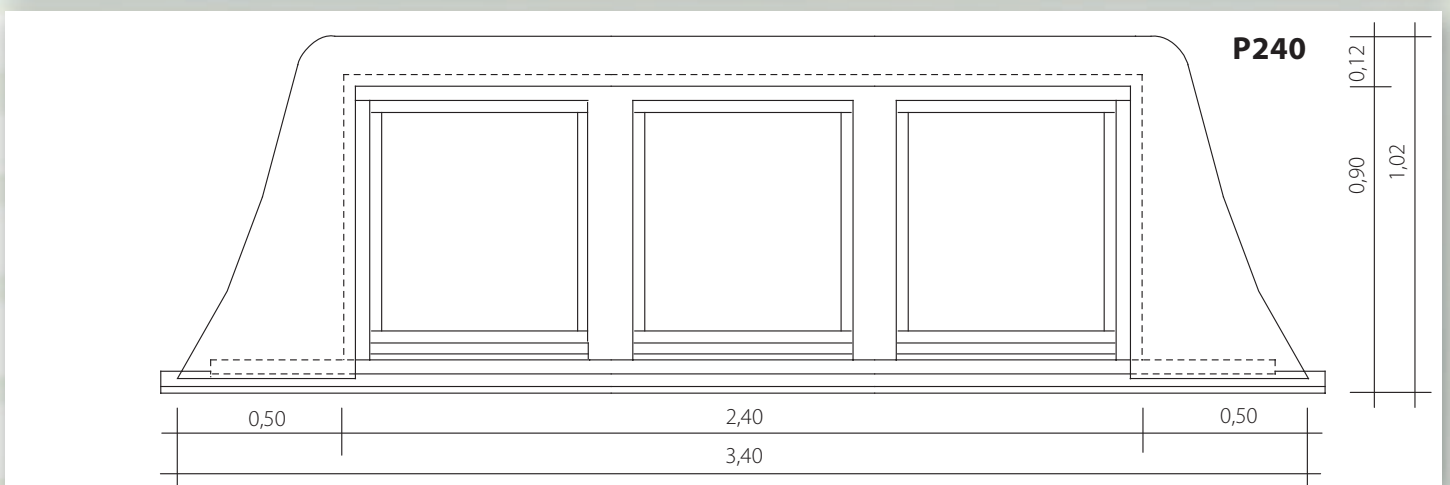
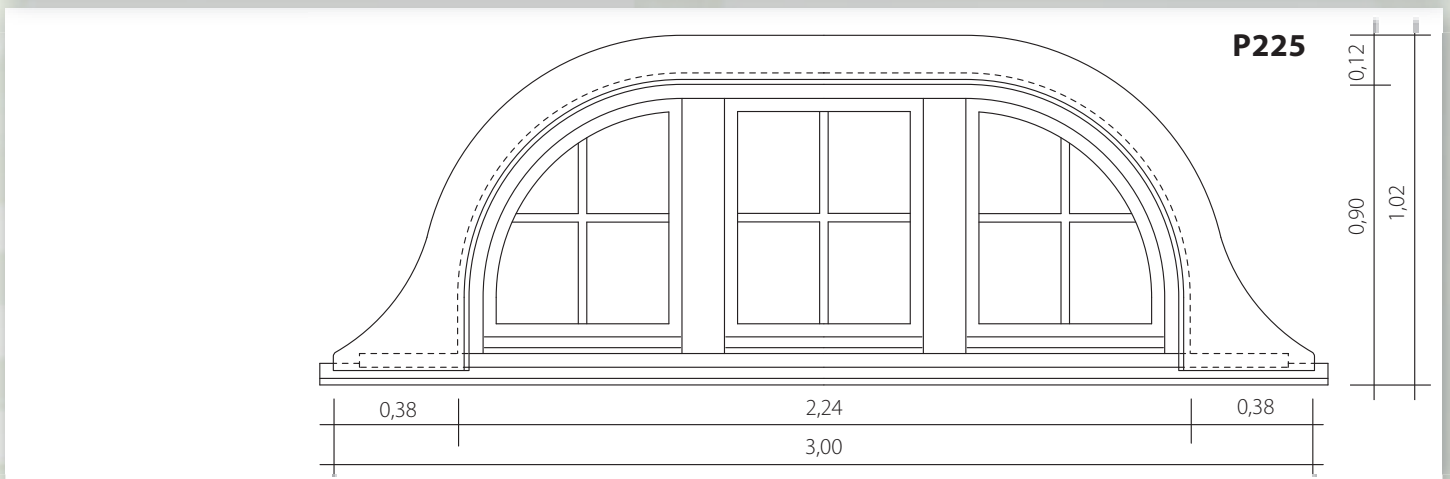
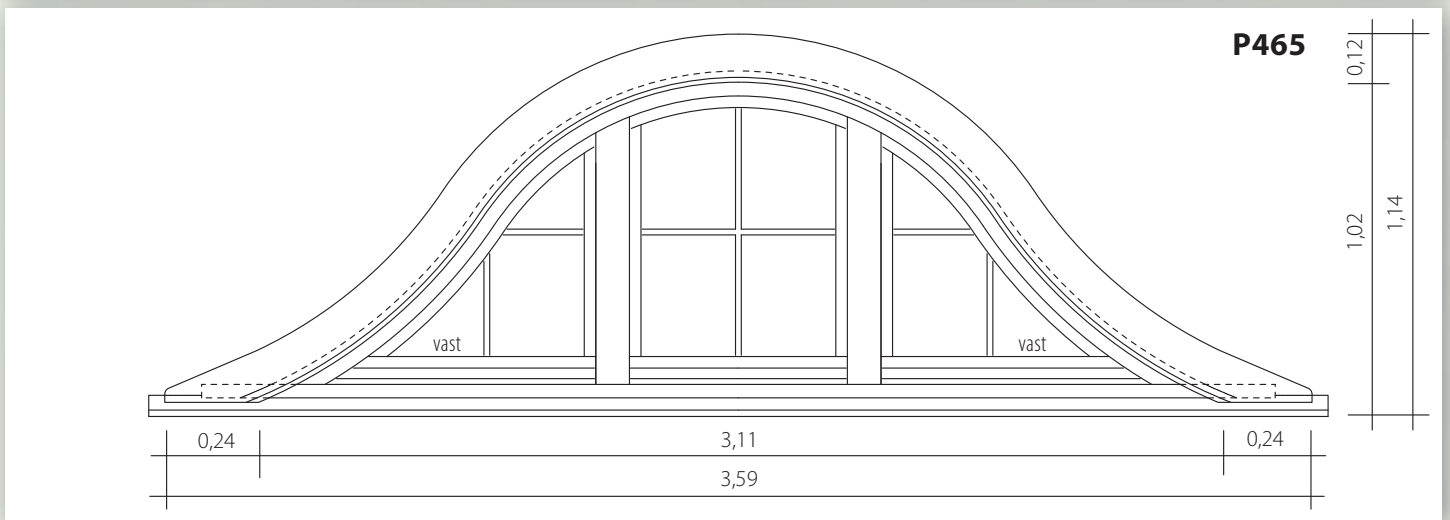

Het standaard programma



Prosman Dakramen

...sieraden voor uw rieten dak



*De modellen P80 / P160 en P240
zijn ook met kruisroeden leverbaar,
meestal uit voorraad.*

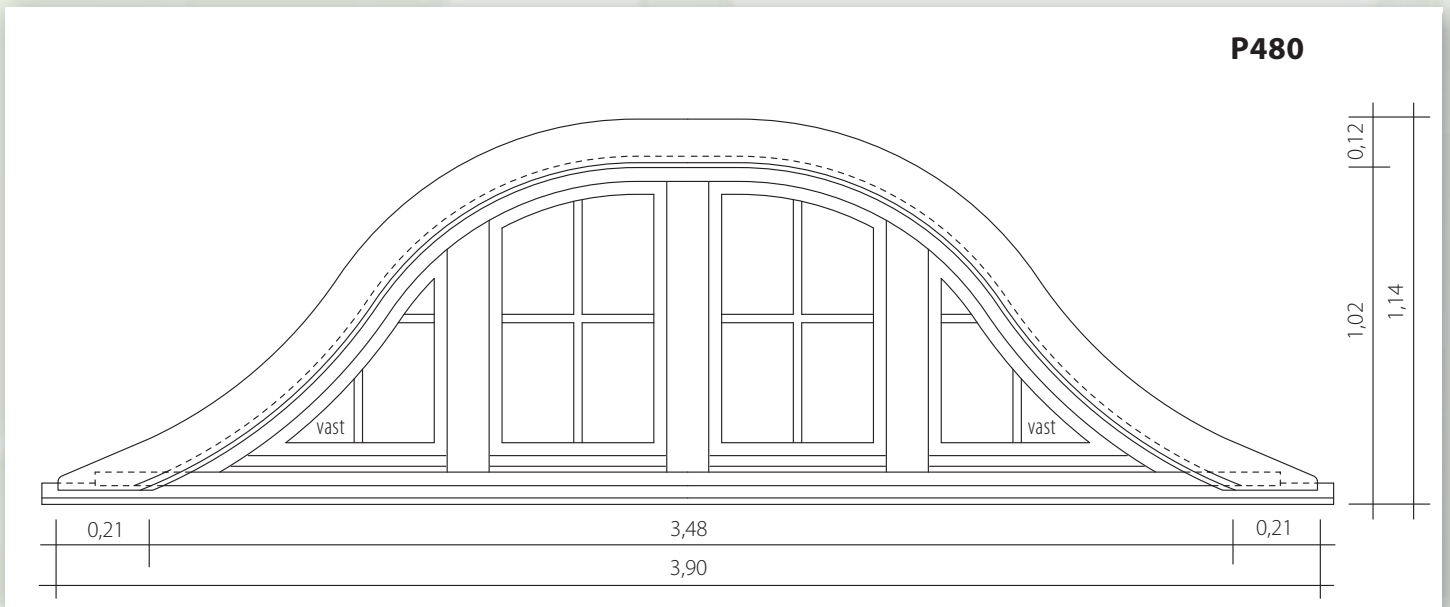
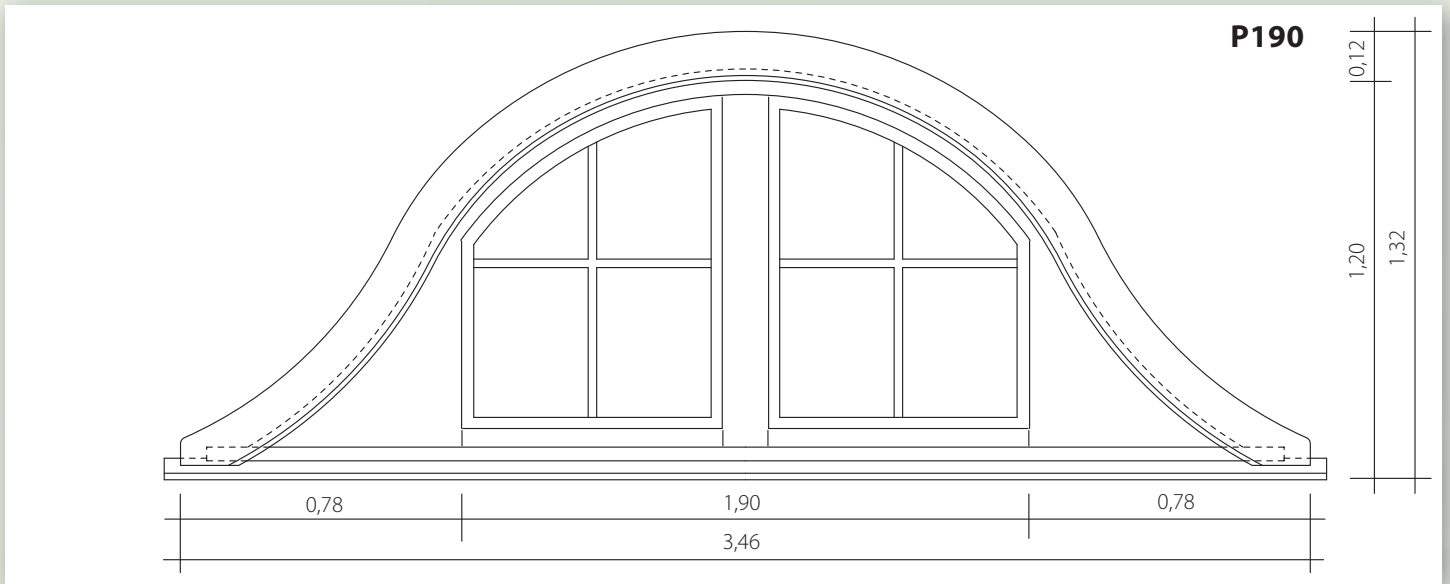

Prosman Dakramen

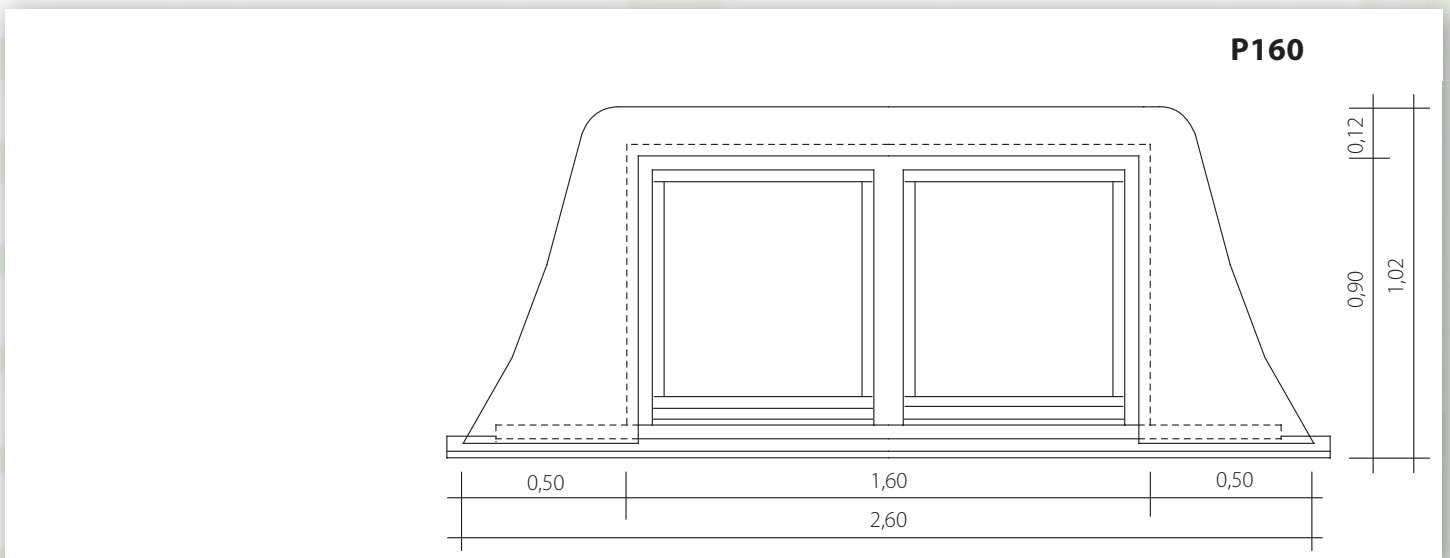

Het standaard programma

P190



P480



...sieraden voor uw rietendak

P160 met kruisroeden



Shutters

Nieuw

Shutters

Getoogde dakramen zijn schitterend, maar bijpassende raamdecoratie en zonwering is vaak lastig te realiseren.

Vanaf nu levert Prosman Dakramen voor al haar standaardtypen dakramen shutters.

Zo regelt u op een efficiënte en elegante manier uw privacy en de hoeveelheid lichtinval.

Uitvoering:

- De shutters zijn gemaakt van hout.
- Standaard kleur wit.
- Montage op de ramen met een schroef/kliksysteem.
- Ramen kunnen na montage van de shutters nog steeds op de kiepstand gezet worden.
- Lamellen van 63mm.
- Inclusief montagehandleiding.
- Eenvoudig te verwijderen om bijv. te reinigen.

Optie:

- De shutters zijn ook in andere RAL-kleuren leverbaar.

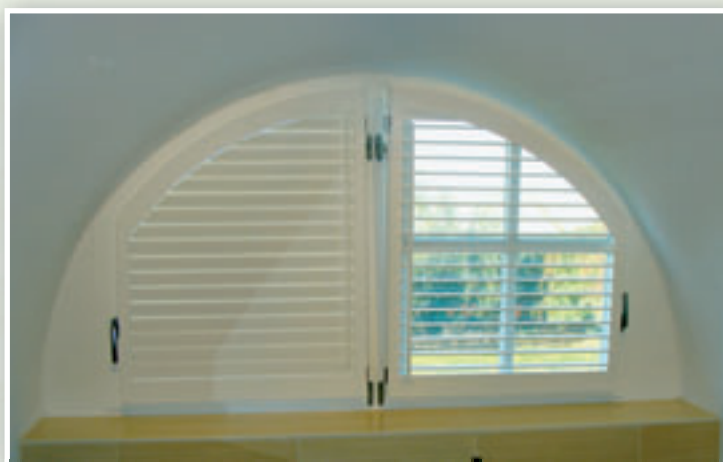

Getoogde gordijnroeden



- Uniek gebogen gordijnroeden voor alle getoogde Prosman Dakramen.
- Compleet geleverd: getoogde gordijnroede, montagesteunen, 2 sierknoppen, bevestigingsmateriaal en handleiding.
- Houtsoort: beuken, overschilderbaar in iedere kleur.
- Uit voorraad leverbaar.



Insektenhorren

Geen muggen, vliegen en andere insekten in huis!

- Past optisch onopvallend bij uw dakraam.
- Goede ventilatiemogelijkheden zonder insekten in huis.
- Gemakkelijk te plaatsen en te verwijderen.
- Leverbaar voor alle standaard Prosman Dakramen (1 raamhor per dakraam).
- Meranti houten raamwerk met zwart horrengaas.
- Inclusief sluitingen en montagepeppen.
- Meranti raamwerk 2x wit gespoten, overschilderbaar in uw kozijnkleur.
- Uit voorraad leverbaar.



Speciale Dakramen

...bij ons geen probleem

Enkele mogelijkheden

Speciale wensen zijn te realiseren binnen enkele weken:

- In vele RAL-kleuren leverbaar.
- 1 of meerdere extra tussenramen.
- Een bredere tussenstijl of blinddeel t.b.v. een scheidingswand.
- Geen roeden, andere roedenverdeling of sierroeden tussen het glas.
- Andere houtsoorten: mahonie, lariks, grenen en eiken.
- Afwijkende kozijnmaten/ontwerp.
- Naar buiten openslaande ramen.
- Montage ventilatierooster.
- Plaatsen geluidswerend, zonwerend of veiligheidsglas.
- Veiligheidshang- en sluitwerk.
- **HR+++ glas (K-waarde 0,7).**

Nieuw



Maatwerk volgens wensen van onze klanten

P90

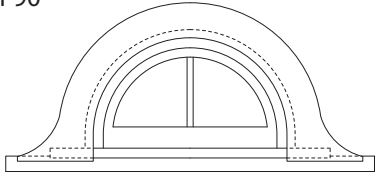

P100

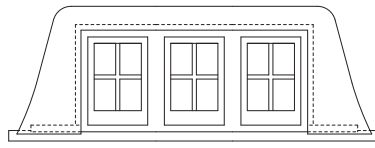

P100

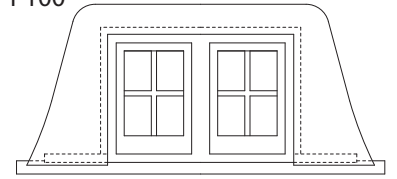

P100 + 2 extra ramen



P100

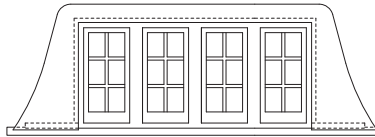

P110

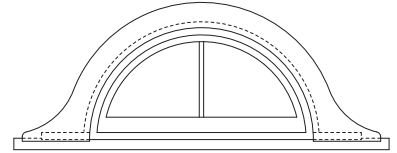

P110

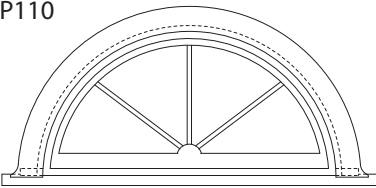

P110

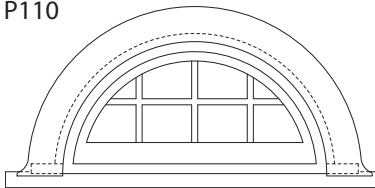

P110 met andere roedenverdeling



P110

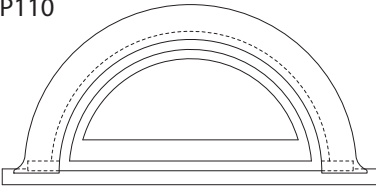

P110

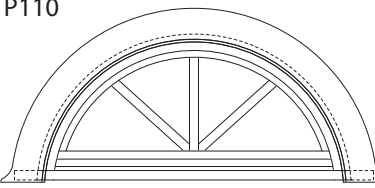

P120

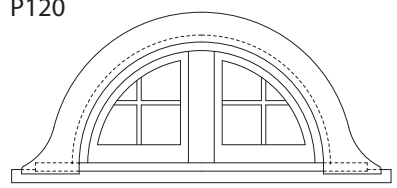

P120

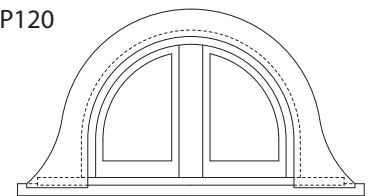

P120

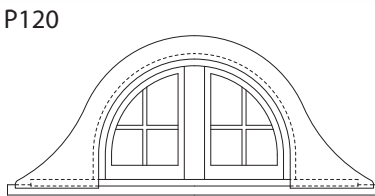

P150

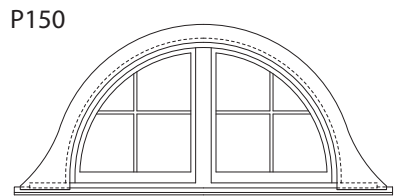

P150

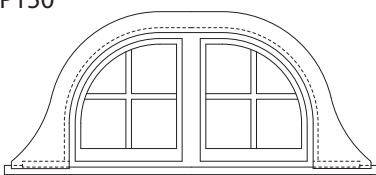

P150

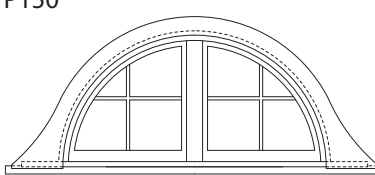

P150

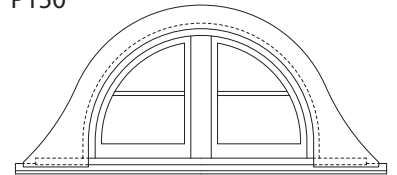

P150

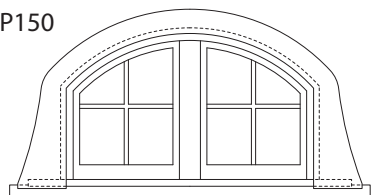

P150 zonder roeden



P150

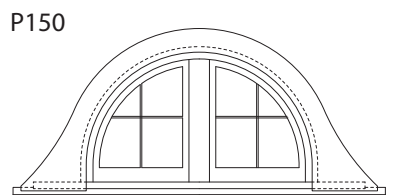

P150

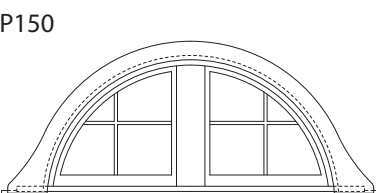

P150

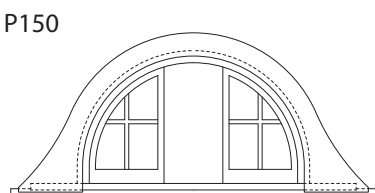

P150

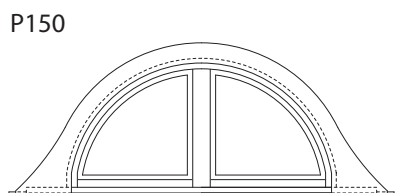

Maatwerk volgens wensen van onze klanten

P150

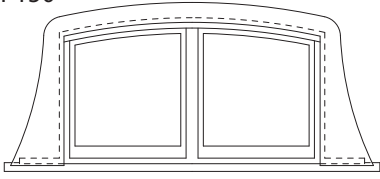

P150

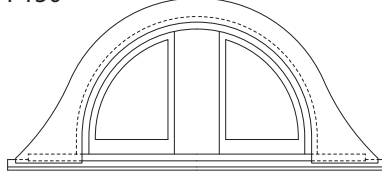

P150

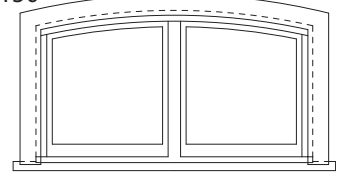

P160

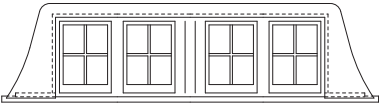

P160 breder, hoger en roeden



P160

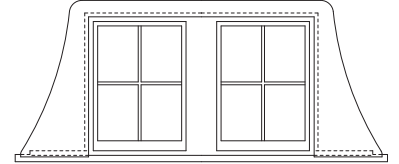

P160 met kruisroeden



P160

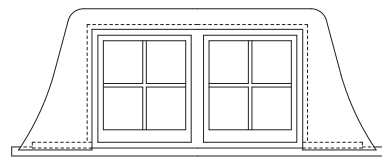

P160

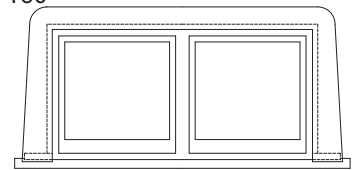

P160

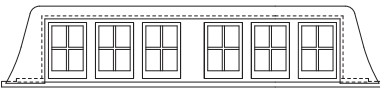

P160

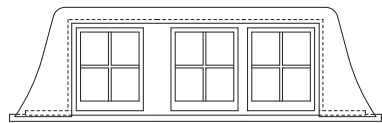

P160

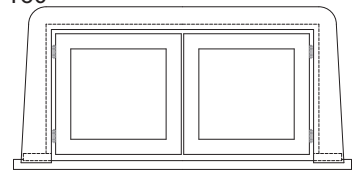

P160

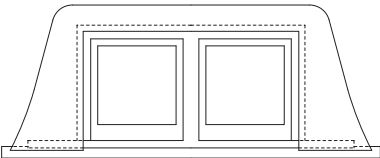

P160

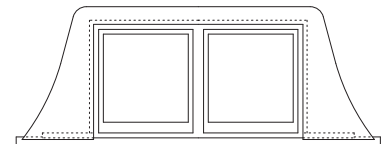

P160 / 240

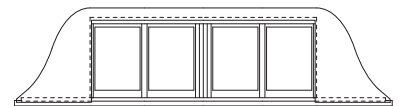

P190

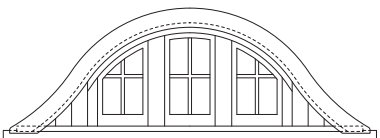

P190 + extra raam, zonder zijwangen



P190

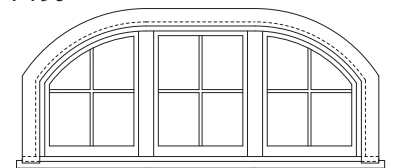

P190

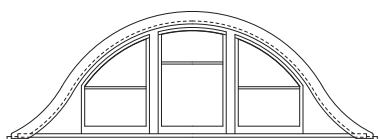

P190

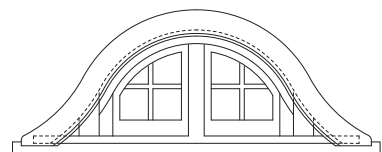

P190

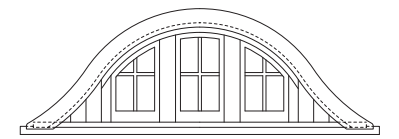

P190

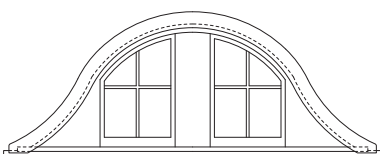

P190

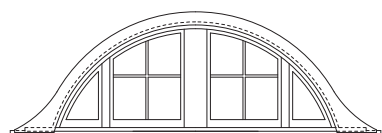

P190 volgens wensen architect



Maatwerk volgens wensen van onze klanten

P200

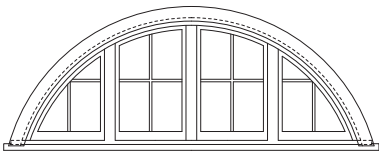

P200 zonder kruisroeden



P225

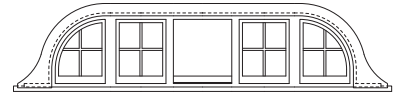

P225 + 2 extra ramen en 4x blinddeel

P225

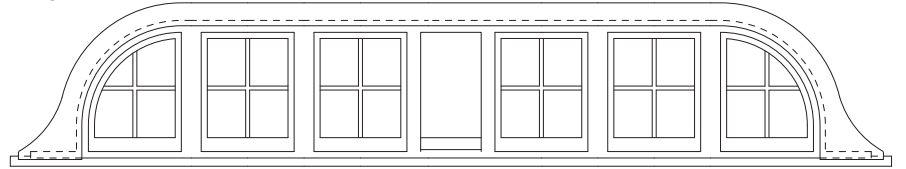

P225

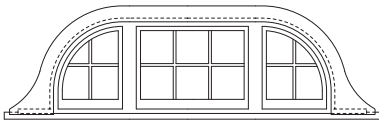

P225

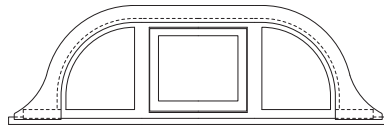

P225

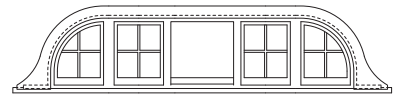

P225

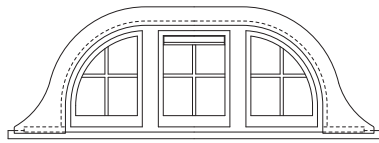

P225

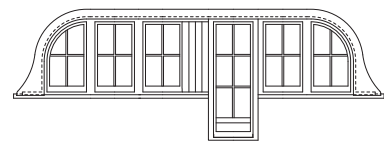

P225

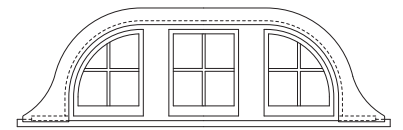

P225

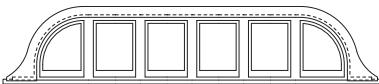

P225 + 3 extra ramen, zonder roeden



P225

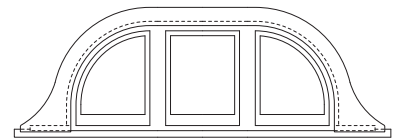

P225

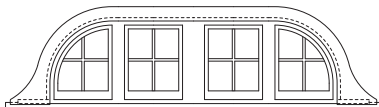

P225

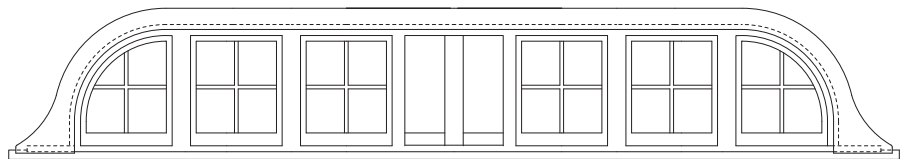

P225

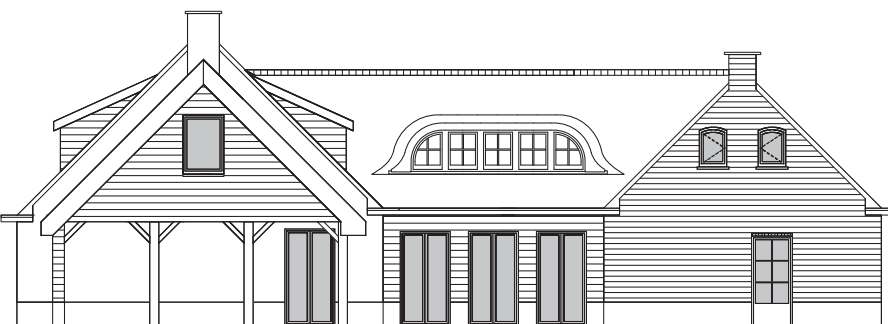

P225

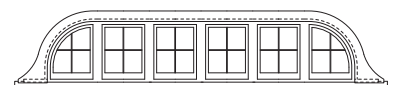

P225 binnenaanzicht



Maatwerk volgens wensen van onze klanten

P225

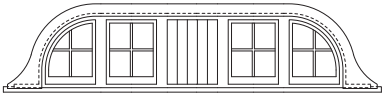

P225

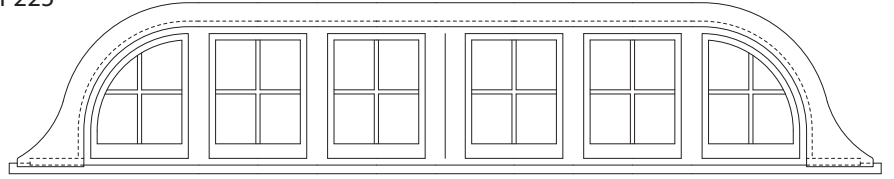

P225

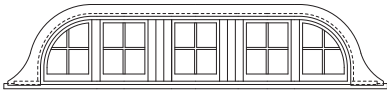

P225

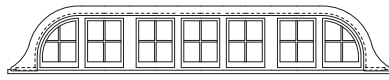

P225

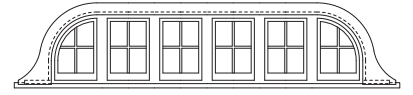

P225

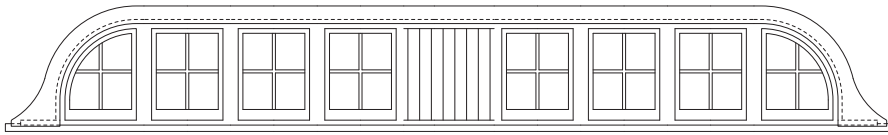

P225

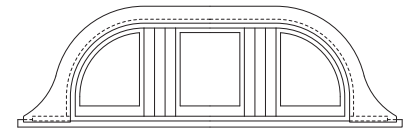

P225

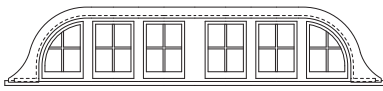

P225

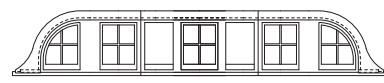

P225

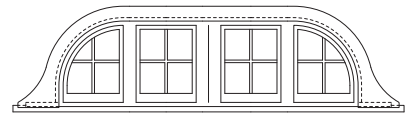

P225

met 2 extra ramen



P225

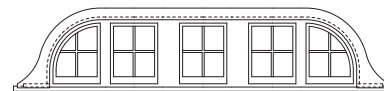

P225 zonder roeden



P225

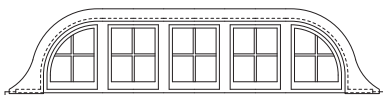

P225

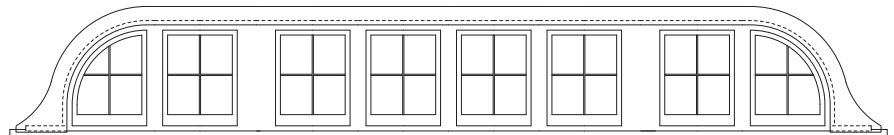

P225

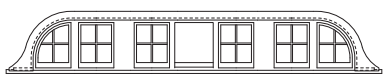

P225

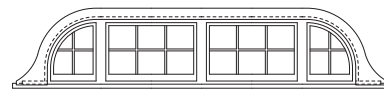

P225

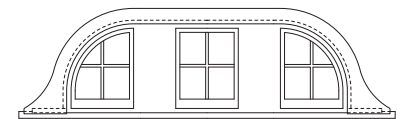

P240

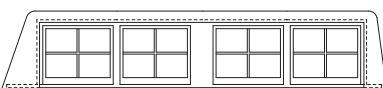

P225

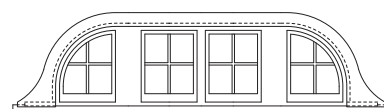

P225

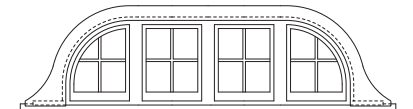

Maatwerk volgens wensen van onze klanten

P240

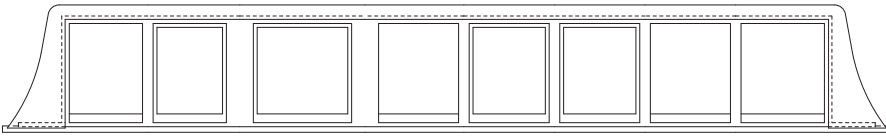

P240

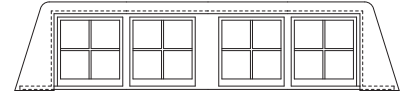

P240

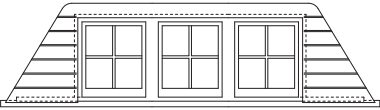

P240

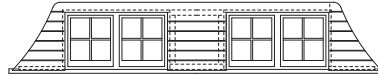

P240

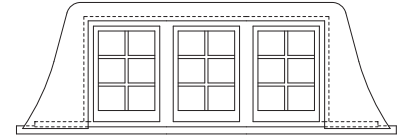

P240

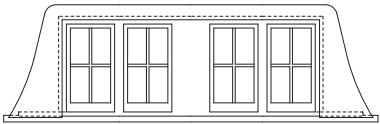

P240

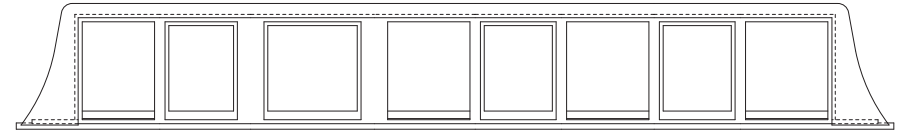

P330

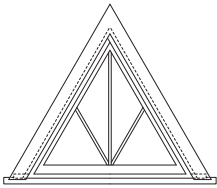

P240

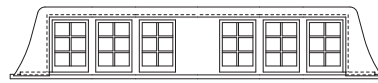

P240

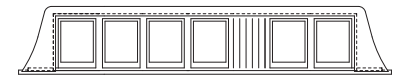

P450



P330 volgens maten klant



P330

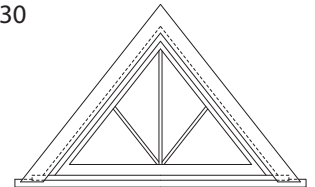

P450



P450



P450

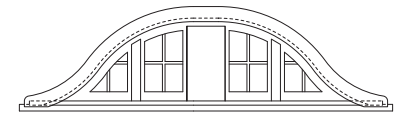

P450



P450



P450

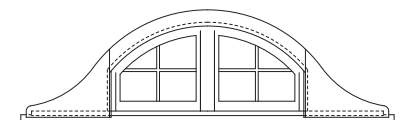

P450



P450

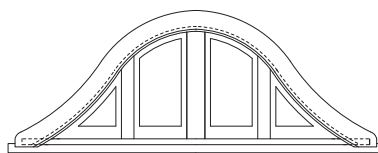

P450
zonder roeden

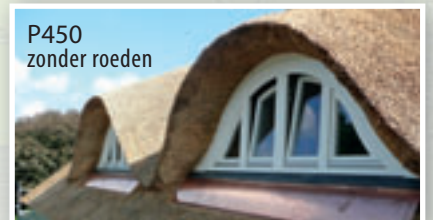

Maatwerk volgens wensen van onze klanten

P450



P450

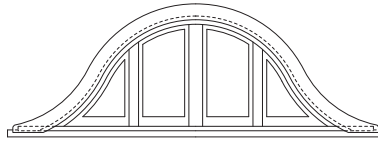

P450

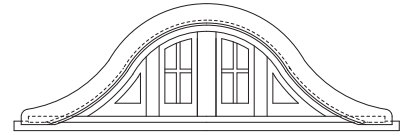

P465

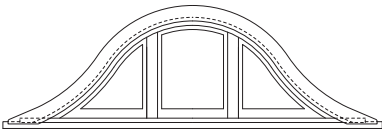

P465

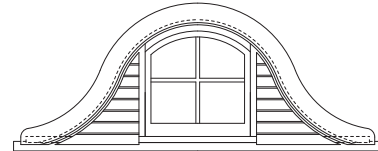

P465

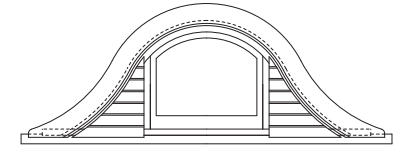

P480

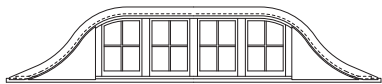

P480 links en rechts rabatdelen



P480

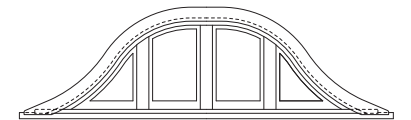

P480

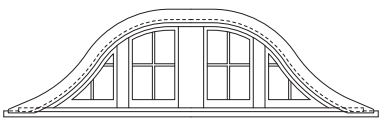

P480

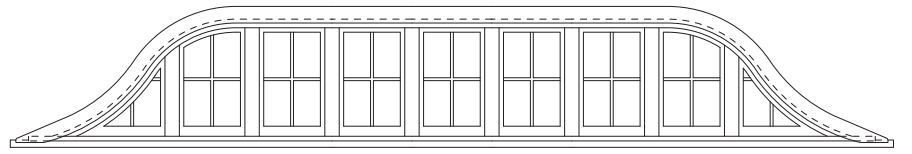

P480



P480

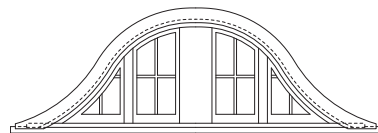

P480

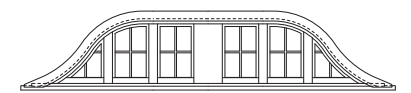

P480

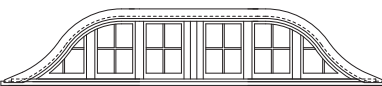

Maatwerk

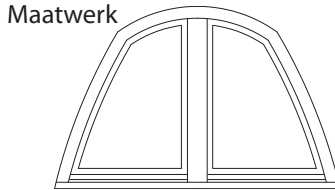

Maatwerk

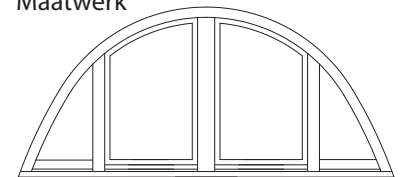

Maatwerk

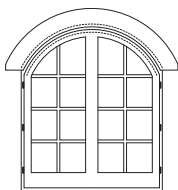

Maatwerk

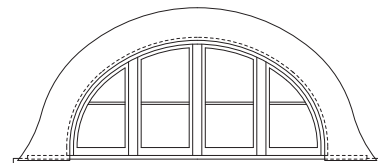

Maatwerk

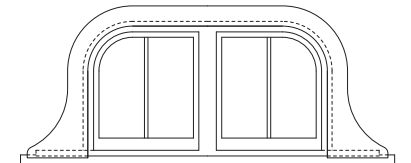

Maatwerk ovaal

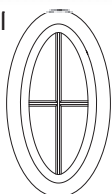

T.b.v. uw bouwtekening zijn de dakramen ook in digitale vorm beschikbaar (CAD-file).





Prosman Kozijnen

*Voor alle kozijnen, ramen, deuren, schuifpuien, shutters etc.
... gespecialiseerd in getoogde dakramen voor rieten daken!*



Uw partner bij nieuwbouw en renovatie!

Bijvoorbeeld dakkapellen, raamkozijnen,
deurkozijnen, deuren en schuifpuien.

Vraag vrijblijvend naar de mogelijkheden
die Prosman Kozijnen u kan bieden.





Prosman Kozijnen

Voor alle kozijnen, ramen, deuren, schuifpuien, shutters etc.
... gespecialiseerd in getoogde dakramen voor rieten daken!

Hoe zal dakraam P150 op mijn rieten dak staan? vraagt u zich af.

Wij kunnen hierbij behulpzaam zijn. Stuur ons een foto van uw woning en wij voorzien deze **gratis*** van het gewenste model.



Heeft u nog geen rieten dak?

Maar wel interesse hoe schitterend uw huidige woning eruit zal zien met een deken van riet erover? Ook daar kunnen wij u helpen. Stuur ons een foto van uw woning en wij voorzien deze **gratis*** van een rieten kap.

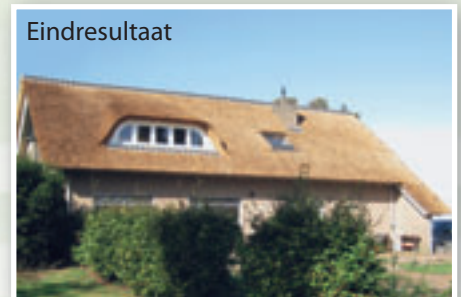

Stuur een e-mail naar: info@prosman.com
foto van uw woning.
adres + contactgegevens.
naar welk model Prosman Dakraam gaat uw voorkeur uit.

Onze showroom en demowoning in Gouderak, Middelblok 146, zijn tijdens werkdagen geopend van 09.00 tot 16.30 uur.
Zaterdag alleen op afspraak. Bezoek ons ook op internet: www.prosman.com

Prosman Riet + Kozijnen
Postbus 3079, 2800 CD Gouda - Holland
Telefoon : 0182 - 37 22 72
Telefax : 0182 - 37 47 20
E-mail : info@prosman.com
Internet : www.prosman.com

Uw dealer:

Gratis*: vraag naar de voorwaarden.